

## Insulating Material Erosion in Atmospheric Non-Thermal Plasma Jet Device

K. M. Ahmed<sup>1</sup>, T. M. Allam<sup>2</sup>, M. A. Abouelatta<sup>\*3</sup>, S. A. Ward<sup>4</sup>, A. A. Lashin<sup>5</sup>, H. M. Soliman<sup>6</sup>

<sup>1,2,5,6</sup>Plasma and Nuclear Fusion Department, Nuclear Research Center, Atomic Energy Authority

<sup>3,4</sup>Shoubra Faculty of Engineering, Benha University, Cairo, Egypt

\*Corresponding author, e-mail: moh\_an1@yahoo.com

### Abstract

*This paper reports on the selection of insulating material types in a developed atmospheric-pressure non-thermal plasma jet (ANPJ-II) device which was operated previously in our laboratory based on the minimum erosion area of the insulator's nozzle. Three identical insulator groups used in our experiment include; Teflon insulator material with different thicknesses of 1.5 mm and 2 mm respectively, and Ceramic insulating material with thickness of 2 mm. ANPJ-II device is operated with each of the three insulator groups. These insulators are operated and analyzed with different operation times for compressed Air or Nitrogen gas with a flow rate of 12 L/min and input voltage of 6 kV. The erosion area of these insulator materials is measured as a function of the operation time. The Ceramic insulator was found to have the minimum erosion area. Also, the temperature of both the cathode and the insulating material (Teflon or Ceramic) are measured to study the effect of operation time and the gas type on the device components.*

**Keywords:** ANPJ-II device, insulator material, teflon, ceramic and erosion ratio.

**Copyright © 2016 Institute of Advanced Engineering and Science. All rights reserved.**

### 1. Introduction

Lately, atmospheric-pressure non-thermal plasma jet (ANPJ) devices attracted great interest [1, 2]. Such device can be easily constructed because they operate at the atmospheric pressure and hence, no vacuum instruments are needed. Also, they can operate with various feeding gases. These devices have relatively low size because the breakdown voltage of the operating gas is in range of kilo-Volts, so the discharge gaps are limited to only few millimeters [3-5]. ANPJ devices have a great interest for their various applications such as biomedical applications [6, 7], food treatment [8], bacteria inactivation [9], teeth bleaching [3] and surface modification [10, 11].

The insulating materials used in high voltage devices are always susceptible to erosion and degradation. Erosion and degradation depend on the type of the insulating material itself, the electrode material, the ambient gas, and the presence of UV. Insulator degradation is the result of material decomposition into conductive metal or carbon species. Also, discharges and local arcing produce surface erosion which ages the insulator's surface [12, 13].

The aim of this work is firstly, to identify the best insulating material used in the developed atmospheric non-thermal plasma jet (ANPJ-II) from three different groups in terms of the minimum erosion area. Second object is to detect the effect of operation time on the temperature of device components such as the cathode and the insulator.

### 2. Experimental Setup

The ANPJ-II used for this work consists of a gas valve and two gas burner orifices one to work as the cathode and the other is the anode as shown in Figure 1. The two electrodes (cathode and anode) are made of brass material and they are separated by sheet of the insulating material. The inner electrode (anode) with a thickness of 3 mm and a diameter of 8 mm and its nozzle has a diameter of 0.5 mm. The outer electrode (cathode) which was cut in our laboratory into a circle with a thickness of 2 mm and a diameter of 7.5 mm and the nozzle has a diameter of 0.4 mm.

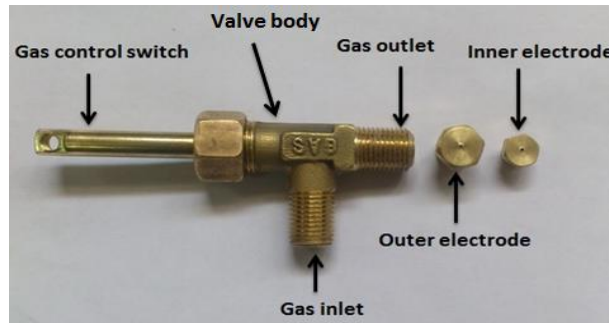

Figure 1. Gas valve and the two electrodes

The two electrodes are separated by the insulating material under consideration (Teflon or Ceramic) which is drilled with nozzle diameter of 1 mm and then stacked together using adhesive glue. The schematic diagram of the two electrodes and the insulator is shown in Figure 2.

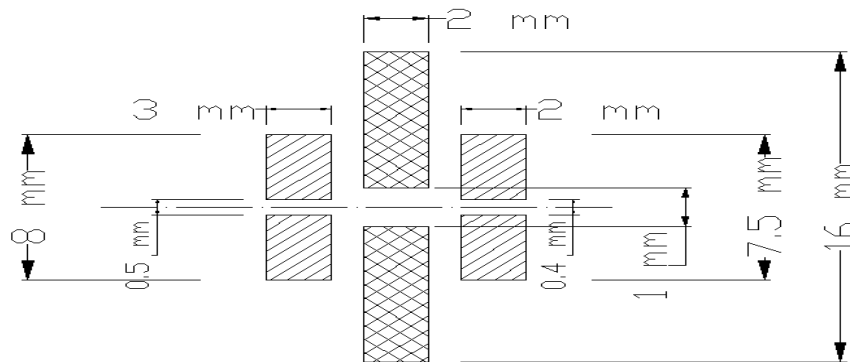

Figure 2. Two electrodes with the insulator

The experimental setup arrangement of the plasma jet is shown in Figure 3. The output terminals of the power supply are connected to the electrodes of the plasma jet via a 2 mm single copper isolated cable. The power supply is connected in series with the electrode system via a high voltage resistor of 25 Ω and a 5 nF capacitor. All the experimental work presented in this paper are carried out with the working gas (compressed Air and Nitrogen gas) of 12 L/min flow rate and the operating input voltage of the device is fixed at 6 kV.

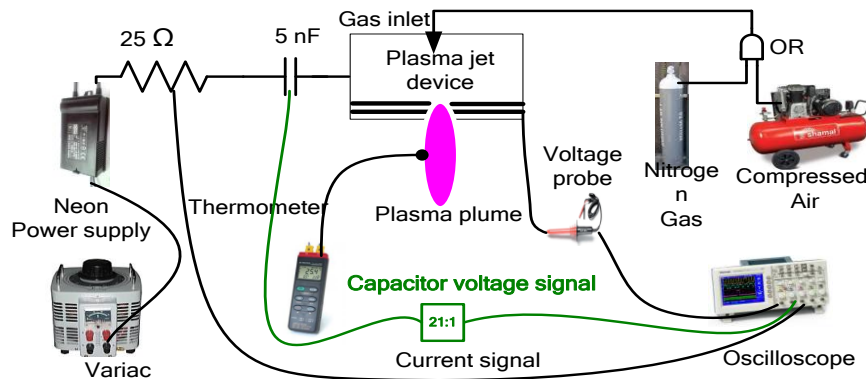

Figure 3. Experimental setup arrangement of the plasma jet device

### 3. Experimental Results

#### 3.1. Insulating Material Selection

During the operation of the ANPJ-II, the generated arc causes significant damage to the insulating material. Thus, the insulating material to be used must be suitable to be able to withstand the arc without getting damaged.

In this paper, the effect of the ANPJ-II device on the insulating material (Teflon or Ceramic) with different thicknesses and with the same operation time, original area of insulator's nozzle =  $0.78 \text{ mm}^2$ ) is investigated on three different groups for both of the two operating gases to choose the most suitable insulating material for device operation. The first group consists of 4 identical Teflon samples having a thickness of 1.5 mm, control sample is used as a reference (operation time  $t=0$ ) and 3 samples, each of them corresponding to the operation times of 15, 30 and 60 min respectively. The second group consists of 4 Teflon samples having a thickness of 2 mm, control sample and 3 samples corresponding to the operation times of 15, 30 and 60 min. The third group consists of 4 Ceramic samples having a thickness of 2 mm, control sample and 3 samples corresponding to the operation times of 15, 30 and 60 min. After the insulator sheet captured with digital camera, the erosion area of the insulator's nozzle was measured for every single operation time mentioned above using measuring area tool in ImageJ software [14] with precision scaling. Figure 4, 5 and 6 show the pictures of the first, second and third group samples respectively.

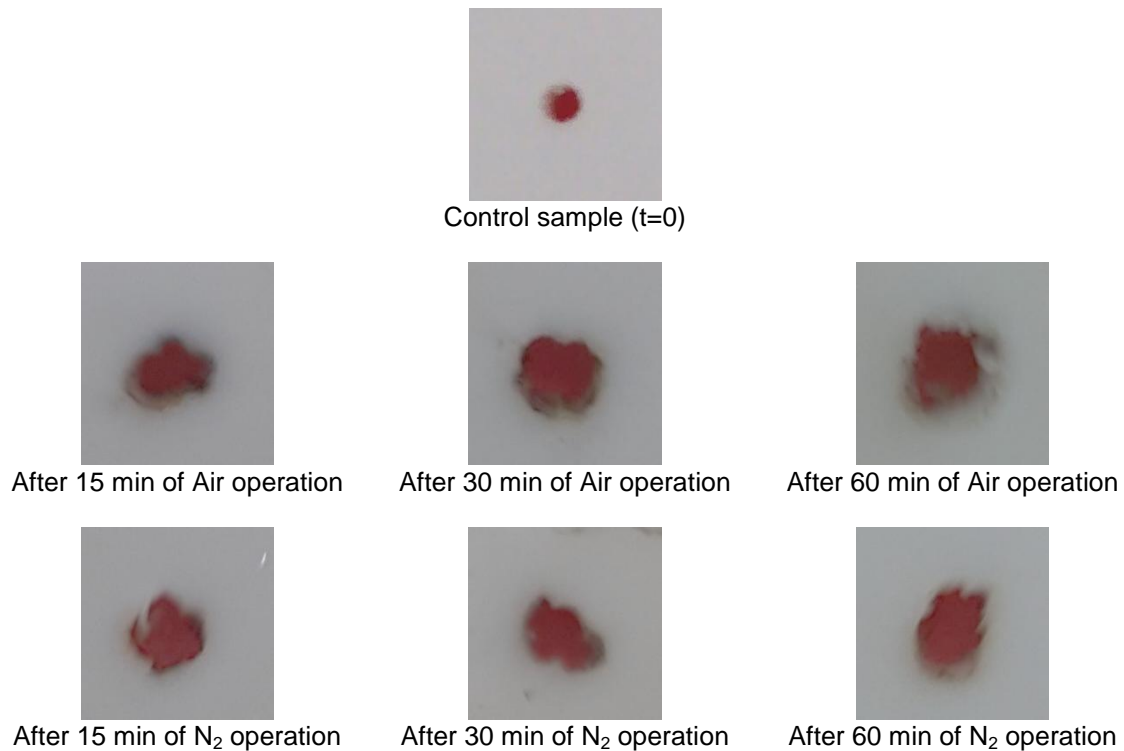

Figure 4. Pictures of first group samples (1.5 mm Teflon)

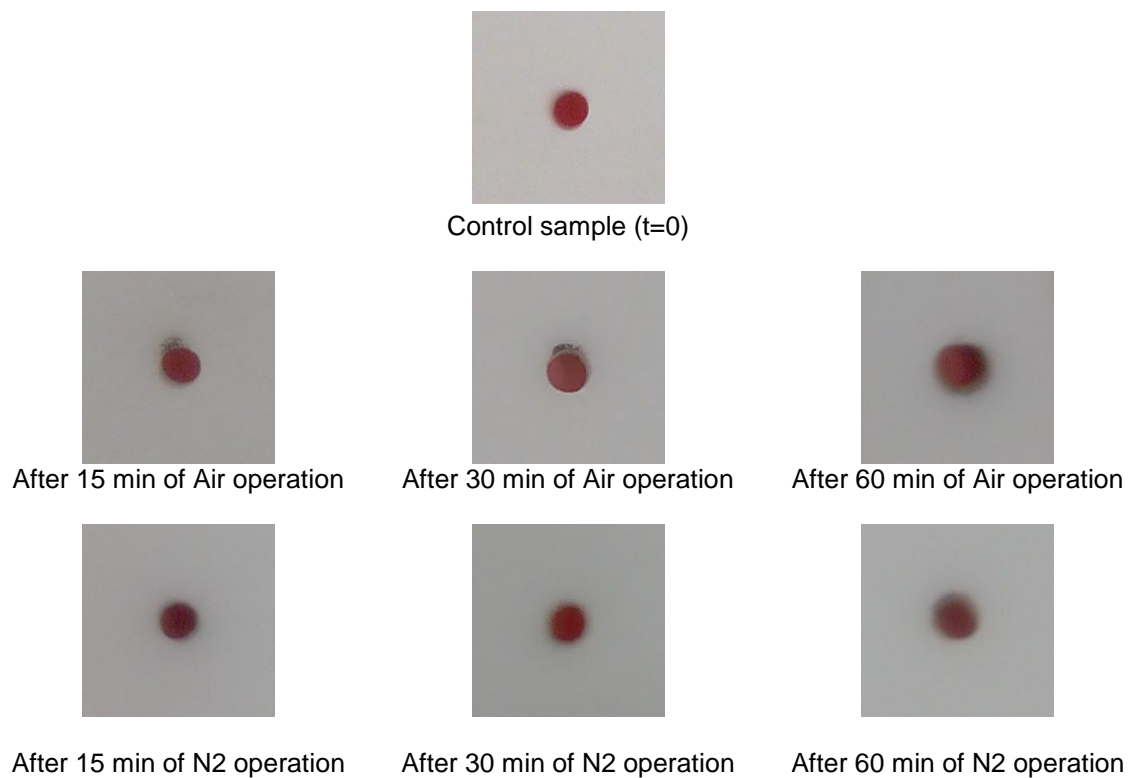
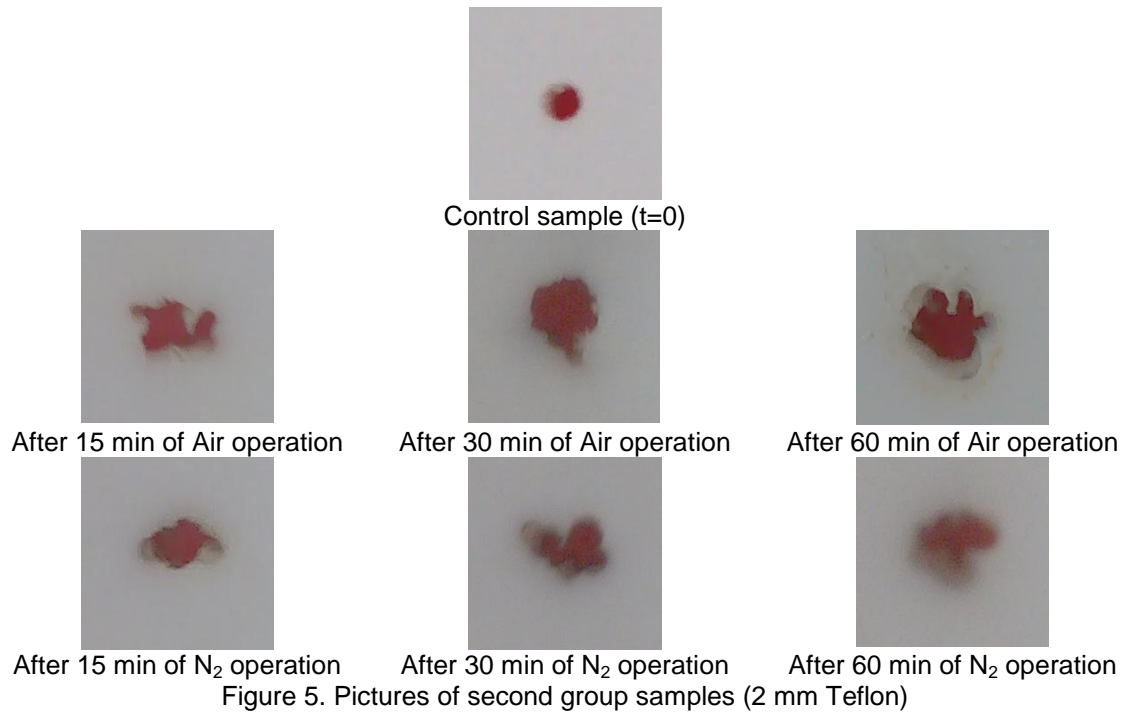

Figure 7, 8 and 9 show the variation of the insulator's nozzle area against operation time of compressed Air and Nitrogen of ANPJ-II device for the three groups of different insulator types and insulator nozzle areas respectively. As shown from these figures, the insulator nozzle

area is increased in general with increasing of operation time for all operation conditions under consideration.

The experimental results cleared that, for the first group where the Teflon with thickness of 1.5 mm, the area of the insulator’s nozzle increases from the original nozzle area of control sample of 0.78 to 5.1 mm<sup>2</sup> i.e. the erosion area = 4.32 mm<sup>2</sup> also from 0.78 to 3.5 mm<sup>2</sup> i.e. the erosion area = 2.72 mm<sup>2</sup>, as the operation time increases from 0 to 60 min for Air and Nitrogen respectively as shown in Figure 7. For the second group (Teflon with thickness of 2 mm), the device operation process showed that, the area of the insulator’s nozzle increases from 0.78 to 4 mm<sup>2</sup> as well as erosion area = 3.22 mm<sup>2</sup> and from 0.78 to 2.7 mm<sup>2</sup> and consequently the erosion area = 1.92 mm<sup>2</sup>, as the operation time increases from 0 to 60 min for Air and Nitrogen respectively as shown in figure 8. Also, for the third group (Ceramic with thickness of 2 mm), the area of the insulator’s nozzle increases from 0.78 to 1.1 mm<sup>2</sup> with erosion area = 0.32 mm<sup>2</sup> and from 0.78 to 0.87 mm<sup>2</sup> with erosion area = 0.09 mm<sup>2</sup> as the operation time increases from 0 to 60 min for Air and Nitrogen respectively as shown in Figure 9.

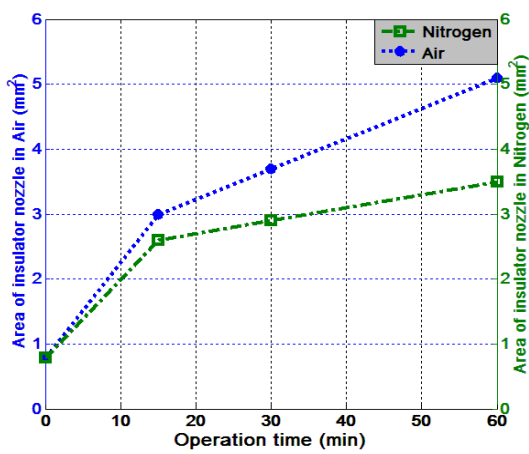

Figure 7. Area of insulator nozzle of first group vs. operation time of ANPJ-II

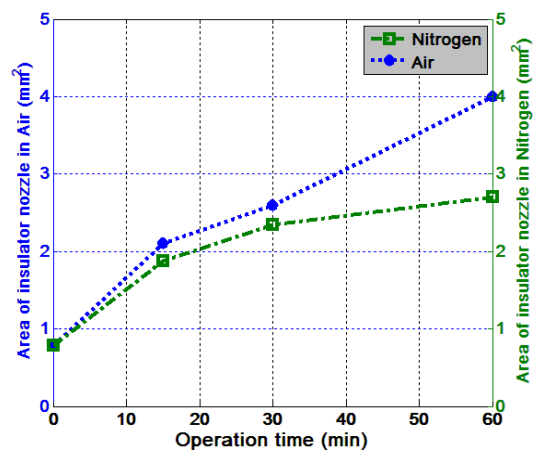

Figure 8. Area of insulator nozzle of second group vs. operation time of ANPJ-II

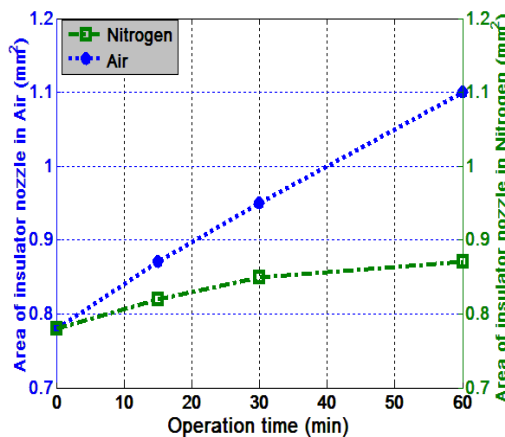

Figure 9. Area of insulator nozzle of third group vs. operation time of ANPJ-II

The ratio of (erosion area,  $E_A$  / original nozzle area  $ON_A$ ) % as a function of operation time for all of the three groups mentioned above is cleared in Figure 10, 11 and 12.

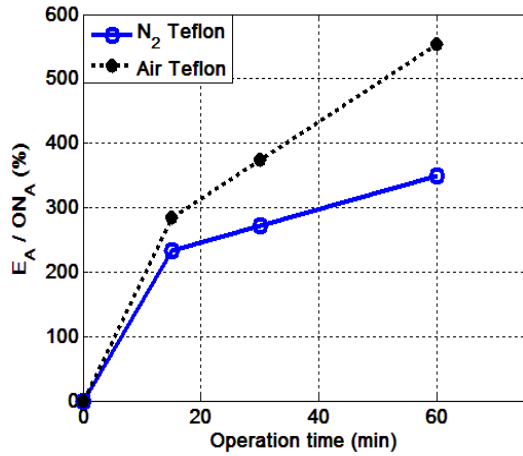

Figure 10. Ratio of (erosion area at different operation times / original area at t=0) % for the first group

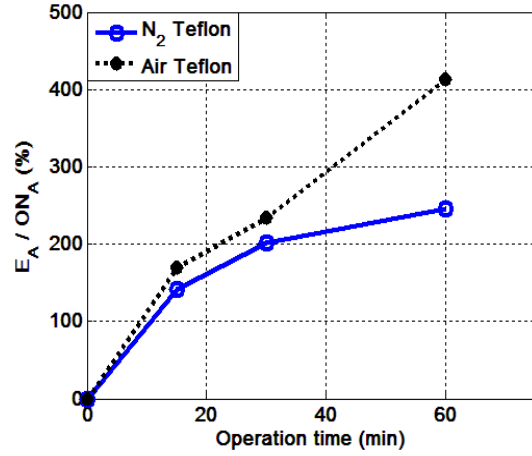

Figure 11. Ratio of (erosion area at different operation times / original area at t=0) % for the second group

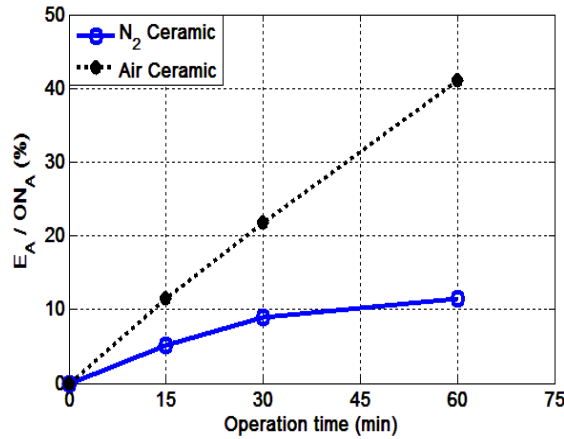

Figure 12. Ratio of (erosion area at different operation times / original area at t=0) % for the third group

As seen from the above figures, for the first group, the ratio of  $E_A/ON_A$  % increases from 0 to 553.8 % and from 0 to 348.7 % for Air and Nitrogen respectively as shown in Figure 10. For the second group, the ratio of  $E_A/ON_A$  % increases from 0 to 412.8 % and from 0 to 246.1 % for Air and Nitrogen respectively as shown in Figure 11. For the third group, the ratio of  $E_A/ON_A$  % increases from 0 to 41 % and from 0 to 11.5 % for Air and Nitrogen respectively as shown in Figure 12. From these results it can be concluded that the Ceramic insulator can work continuously almost ten times longer than Teflon using compressed Air and twenty one times longer than Teflon using the Nitrogen gas.

These results identify that the operation time of the ANPJ-II device affects the insulating material's shape and nozzle area in a bad manner. All the above results indicate that the Ceramic material is more suitable for the operation of ANPJ-II device than the Teflon insulator which used in the ANPJ device [1, 2]. It is worthy mentioning that the Teflon insulator gets eroded in the ANPJ-II much more than the previous design of ANPJ because the developed design is made of Brass which has lower specific heat ( $0.385 \text{ J.g}^{-1}.\text{K}^{-1}$ ) than the Aluminum ( $0.897 \text{ J.g}^{-1}.\text{K}^{-1}$ ) [15].

### 3.2. Temperature Measurements

The insulator and the cathode temperatures were measured for both of the two insulating materials (Teflon and Ceramic) each of them had a thickness of 2 mm using a BK Precision 710 k-type digital thermometer at different operation times for the ANPJ-II. The temperature  $T$ , rises of Teflon and cathode in Air and Nitrogen gases at different operation times of ANPJ-II device ( $T_{\text{at different operation times}} - T_{\text{before operation, } t=0}$ ) are shown in Figure 13 and Figure 14 respectively. The temperatures rise of Ceramic and cathode at different operation times of ANPJ-II device in Air and Nitrogen ( $T_{\text{at different operation times}} - T_{\text{before operation, } t=0}$ ) are shown in Figure 15 and Figure 16 respectively.

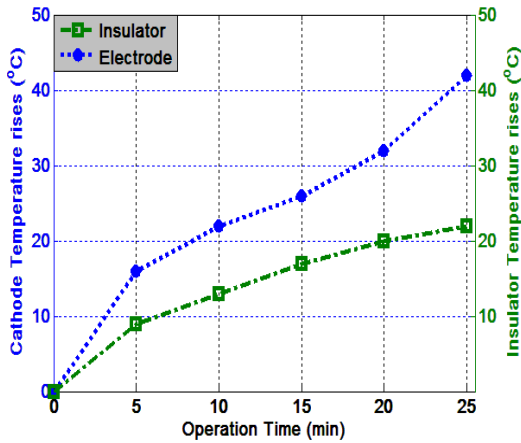

Figure 13. Temperature rises of cathode and insulator vs. operation time of Teflon in ANPJ-II (Air)

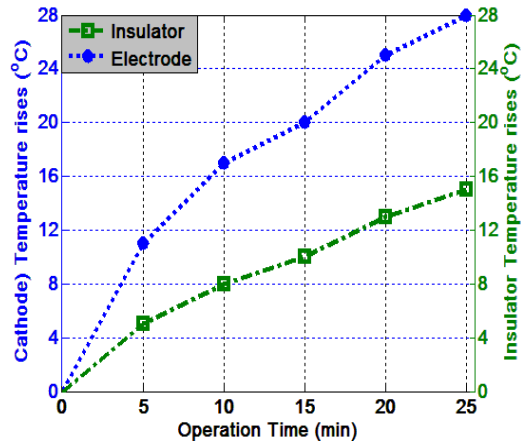

Figure 14. Temperature rises of cathode and insulator vs. operation time of Teflon in ANPJ-II (Nitrogen)

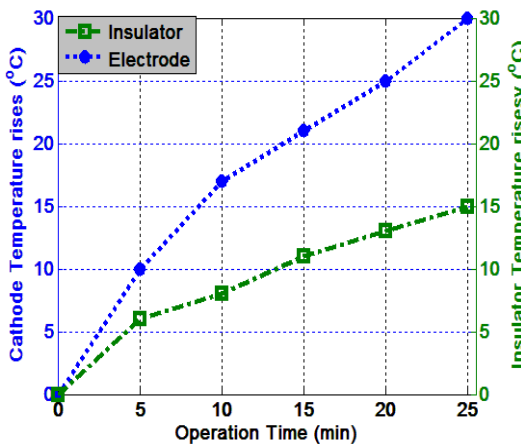

Figure 15. Temperature of cathode and insulator vs. operation time of Ceramic in ANPJ-II (Air)

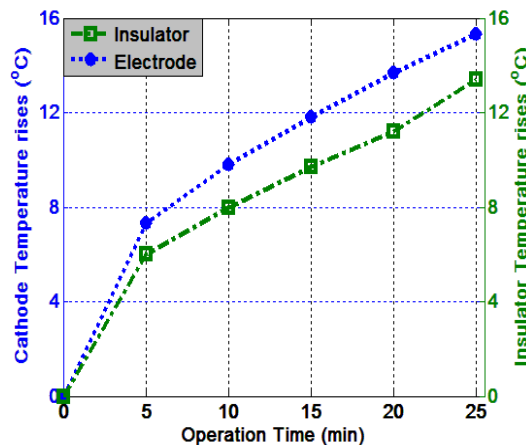

Figure 16. Temperature of cathode and insulator vs. operation time of Ceramic in ANPJ-II (Nitrogen)

Figure 13 indicates that the 25 min Air operation time rises the temperature of Teflon insulator material and cathode by 22 °C and 42 °C respectively. Figure 14 clears that the 25 min Nitrogen operation time rises the temperature of insulator and cathode by 15 °C and 28 °C respectively. While for Ceramic insulator material, Figure 15 and 16 verify that the 25 min Air and Nitrogen operation time rise the temperature of insulator and cathode by 15 °C, 30 °C and

13.4 °C, 15.3 °C respectively. This may be related to the fact that Nitrogen gas acts as a coolant [16,17]. These results are summarized in Table 1.

Table 1. Temperature rises of the two insulators for the two gases

Insulator	Air	% of ambient temp.	Nitrogen	% of ambient temp.
Ceramic	15 °C	48.39 %	13.4 °C	47.35 %
Teflon	22 °C	115.79 %	15 °C	78.95 %

#### 4. Conclusion

Measurements of insulator nozzle area or ratio between erosion nozzle area and its original area for three different insulators, at different operation times of our device ANPJ-II for Nitrogen gas or compressed Air, confirmed that for Nitrogen gas, the Ceramic insulator with thickness of 2 mm has a smaller erosion nozzle area than the other two Teflon insulators with thicknesses of 1.5 and 2 mm respectively for the same operation time and discharge conditions which means that if the Teflon insulator has to be replaced after T time, the Ceramic insulator shall be replaced after  $10 \cdot T$  when using compressed Air and  $21 \cdot T$  when using Nitrogen gas. Results of cathode and the three insulators temperature as a function of operation time concluded that the temperature rises for the cathode or the insulators during the device operation time of Air is higher than that of Nitrogen gas. Also, the operation time of our device has a less effect on Ceramic temperature than that of Teflon material for compressed Air and Nitrogen gas. This may be related to the fact that Nitrogen gas acts as a coolant. The ANPJ-II device operation is found to be best optimized for Nitrogen gas and Ceramic insulator.

#### References

- [1] KM Ahmed, TM Allam, HA Elsayed, HM Soliman, SA Ward, EM Saied. Design, Construction and Characterization of AC Atmospheric Pressure Air Nonthermal Plasma Jet. *Journal of Fusion Energy*. 2014; 33(6): 627-633.
- [2] TM Allam, SA Ward, HA El-sayed, EM Saied, HM Soliman, KM Ahmed. Electrical Parameters Investigation and Zero Flow Rate Effect of Nitrogen Atmospheric Nonthermal Plasma Jet. *Energy and Power Engineering*. 2014; 6: 437-448.
- [3] HW Lee, SH Nam, AAH Mohamed, GC Kim, JK Lee. Atmospheric Pressure Plasma Jet Composed of Three Electrodes: Application to Tooth Bleaching. *Plasma Processes and Polymers*. 2010; 7: 274-280.
- [4] XinPei Lu, ZhongHe Jiang, Qing Xiong, ZhiYuan Tang, XiWei Hu, Yuan Pan. An 11 cm long atmospheric pressure cold plasma plume for applications of plasma medicine. *Applied Physics Letters*. 2008; 92: 81-502.
- [5] YC Hong, SC Cho, JH Kim, HS Uhm. A long plasma column in a flexible tube at atmospheric pressure. *Physics of Plasmas*. 2007; 14: 1-4.
- [6] Elham Janani, Mahsa Ale-Ebrahim, Pejman Mortazavi. In Vitro and in Vivo studies of the Effects of Cold Argon Plasma on Decreasing the Coagulation Time. *Iranian Journal of Medical Physics*. 2013; 10(1-2): 31-36.
- [7] M Laroussi, X Lu. Room-temperature atmospheric pressure plasma plume for biomedical applications. *Applied Physics Letters*. 2005; 87: 113-902.
- [8] RX Wang, WF Nian, HY Wu, HQ Feng, K Zhang, J Zhang, WD Zhu, KH Becker, J Fang. Atmospheric-pressure cold plasma treatment of contaminated fresh fruit and vegetable slices: inactivation and physiochemical properties evaluation. *The European Physical Journal D*. 2012; 66: 276.
- [9] Peng Sun, Haiyan Wu, Na Bai, Haixia Zhou, Ruixue Wang, Hongqing Feng, Weidong Zhu, Jue Zhang, Jing Fang. Inactivation of Bacillus subtilis Spores in Water by a Direct-Current, Cold Atmospheric-Pressure Air Plasma Microjet. *Plasma Processes and Polymers*. 2012; 9: 157-164.
- [10] Ying Jin, Chun Sheng Ren, Qian Qian Fan, Huijie Yan, Zhifen Li, Jialiang Zhang, Dezhen Wang. Surface Cleaning Using an Atmospheric-Pressure Plasma Jet in O<sub>2</sub>/Ar Mixtures. *IEEE Transactions on Plasma Science*. 2012; 40(10): 2706-2710.
- [11] KM Ahmed, TM Allam, HA El-sayed, H Soliman, S Ward, E Saied. Wettability Improvement of Mylar substrate using N<sub>2</sub> gas and Air Atmospheric Nonthermal Plasma Jet. *Arab Journal of Nuclear Science and Applications*. 2016; 94(2): 40-47.
- [12] LL Grigsby. Electric Power Generation, Transmission, and Distribution. 3rd edition. USA: CRC Press. 2012.
- [13] TG Engel, M Kristiansen. Mechanisms and Predictors of Insulator Degradation and Erosion Produced



- by Pulsed High-Current Surface Discharges. *IEEE Transactions On Plasma Science*. 2009; 37(9): 1863-1870.
- [14] <http://rsb.info.nih.gov/ij/download.html>.
- [15] [https://en.wikipedia.org/wiki/Heat\\_capacity](https://en.wikipedia.org/wiki/Heat_capacity).
- [16] Z Hamedon, TT Mon, S Sharif, VC Venkatesh, ARM Masri, E Sue-Rynley. Performance of Nitrogen Gas as a Coolant in Machining of Titanium. *Advanced Materials Research*. 2011; 264-265: 962-966.
- [17] AEI Elshwain, N Redzuan. Effect of Cooling/Lubrication using Cooled Air, MQL + Cooled Air, N2 and CO2 Gases on Tool Life and Surface Finish in Machining – A Review. *Advanced Materials Research*. 2014; 845: 889-893.