

Simulation of the Lightning Back-Flashover for Medium Voltage Distribution Network

Osama El-Sayed Gouda¹, Noura Ahmed Elshesheny²

¹Department of Electrical Power and Machines, Faculty of Engineering, Cairo University, Giza, Egypt

²Elec. Engineering Dept., Faculty of Engineering, Benha University, Benha, Egypt

*Corresponding author, e-mail: prof_ossama11@yahoo.com

Abstract

Lightning strikes represent a considerable cause of short interruptions in electrical overhead line networks. The over voltages caused by lightning cannot be avoided but their influence can be limited by appropriate over voltage protection. This paper presents analysis study on some factors affecting the back flashover of Egyptian 66 kV distribution lines using Alternative Transient Program (ATP). The study includes the modeling of 66 kV distribution lines, the effects of magnitude and the front and tail times of lightning wave on the back flashover voltages, the effects of the striking distance, and the using of counterpoise wires on the back flashover on the 66 kV line towers. In this paper the 66 kV lines sag is neglected and the soil ionization by the flow of the stroke current is considered.

Keywords: back flashover, ATP, overhead transmission line, induced voltage, counterpoise wires

Copyright © 2016 Institute of Advanced Engineering and Science. All rights reserved.

1. Introduction

Lightning has continued to be the major cause of outage and damage to power system and equipment. Knowledge on protection scheme and proper selection of the protection devices remain to be important criteria for the engineers [1]. The first stroke is most often more severe than the subsequent strokes. The low current continues to flow between two strokes, increase the total energy injected to the struck object. The transient voltage from the lightning strike is generated by indirect stroke and or direct stroke. When lightning hits the ground several hundred meters away from the line (indirect stroke), the electric and magnetic fields of the lightning channel can induce high voltage on the line insulators of transmission and distribution lines to spark over causing a short circuit of the system.

For direct stroke, voltage and current waves propagate from this stroked location to both sides of line, which reflect in every place where there is a change in surge impedance. Probability of direct lightning strike to conductor phase is decreased by using of ground wires. Most often, lightning strikes the phase conductor of the power line; in that case, a traveling voltage wave is generated on the line; it travels along the line and is impressed across the terminal of an apparatus or most often the insulator between the phase conductor and the cross-arm of the tower. If the voltage is high enough, the insulator flashes over causing a short circuit of the system. Many overhead power lines are equipped with shield wires to shield phase conductors. Even then, shielding failures occur when lightning bypasses the shield wires and strikes a phase conductor [2].

An overhead line back flashover occurs when the tower or shield wire is struck by lightning. The lightning current passes to the earth via the tower. A traveling voltage is generated which travels back and forth along the tower, being reflected at the tower footing and the tower top, causing a voltage difference between the tower cross-arm and the phase conductors. The insulator will flash over if their transient voltage exceed it's withstand level (back flashover). Thus, assuming the lightning channel to be a current source, the transient voltages across the insulator of the phase conductor are generated in three ways (i) lightning striking the phase conductor (shielding failure), (ii) lightning striking the tower or the shield wire (back flashover), and (iii) lightning striking the nearby ground (indirect stroke). The severity of these three types of transient voltage is influenced by different lightning parameters [3].

In this paper analysis is carried out to study the factors affecting on the back flashover voltages of 66 kV overhead transmission lines, the effect of magnitude and the front time of lightning impulse, the striking distance, and the effect of counterpoise wire of 66 kV overhead transmission tower on the back flashover are studied.

2. Modeling of the System under Study

2.1. Lightning Impulse Source Model

The magnitude of impulse current due to a lightning discharge is probability function. In this paper the lightning stroke is modeled by a current source and parallel resistance, which represents the lightning path impedance. Lightning path impedance value is taken to be 400 Ω , which was derived by Bewley [4, 5]. The lightning stroke model can be simulated by the ATP program.

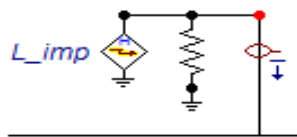

Figure 1. Simulation of Lightning Stroke Model

2.2. Tower Footing Resistance

The tower footing resistance can be formulated as a function of the limiting current I_g and the lightning current I . The tower footing resistance taking the soil ionization into consideration is determined by using the current dependence of the footing resistance as follows [5].

$$R_f = \frac{R_g}{\sqrt{1 + \frac{I}{I_g}}} \quad (1)$$

Where R_g is the tower footing resistance at low current and low frequency, according to Dwight [6], and Sunde [7], its value depends on the soil resistivity, used rod configuration and its length and diameter, it can be taken equals 5-12 ohms, R_f is the tower footing resistance taking the soil ionization by stroke current into consideration in ohms, I_g is the limiting current to initiate sufficient soil ionization, in kA, I is the surge current into ground in kA, the limiting current is a function of the soil ionization and is given by:

$$I_g = \frac{1}{2\pi} \left[\frac{E_o \rho_o}{R_g^2} \right] \quad (2)$$

Where ρ_o is soil resistivity, ohm-m, E_o is soil ionization gradient (about 300 kV/m) [5].

2.3. Double Circuit 66 kV Transmission Line Model

66 kV double circuit transmission tower configuration and dimensions is shown in Figure 2 [8]. The span length equals 300 m. The transmission tower model consists of four sections is divided to upper, middle and lower phase cross arm positions as shown in Figure 3 [9-11]. Each section consists of a loss free transmission line and a lumped constant consisting of a damping resistance shunted by the inductance. The parameters of 66 kV double circuit tower model are given in Table 1. The resistances and the inductances of tower structure sections are calculated from the tower dimension as in [5], [12, 13].

$$R_i = \frac{-2Z_{i1} \cdot \ln \sqrt{\alpha}}{h_1 + h_2 + h_3} \cdot h_i \quad i= 1- 3 \quad (3)$$

$$R_4 = -2Z_{i4} \ln \sqrt{\alpha} \quad (4)$$

$$L_i = \alpha \cdot R_i \frac{2H}{C_o} \quad i= 1- 4 \quad (5)$$

$$H = h_1 + h_2 + h_3 \quad (6)$$

Where Z_{i1} , Z_{i2} and, Z_{i3} is the surge impedance from tower top to the upper phase arm, upper phase to middle phase arm, and middle phase to lower phase arm, ohm, Z_{i4} is the surge impedance from lower phase arm to tower bottom, ohm, α is the attenuation coefficient along the tower, C_o is the propagation velocity of the traveling wave along the tower, and it is taken to be 300 m/ μ s, light velocity in free space, h_1 is the tower height from tower top to upper phase arm, h_2 is the tower height from upper phase to the middle phase arm, h_3 is the tower height from middle phase to the lower phase arm, h_4 is the tower height from lower phase to tower bottom.

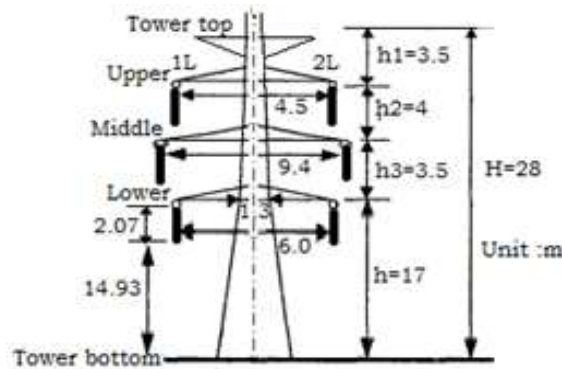

Figure 2. 66 kV Transmission Tower Configurations (all dimensions are in meters)

Table 1. Parameters and Dimensions of 66 kV Double Circuit Tower Model [6]

Name	Symbol	Value
Tower surge impedance	zt1= zt2 = zt3	220 Ω
	zt4	150 Ω
Surge propagation velocity	co	300 m/ μ s
Attenuation coefficient along the tower	α	0.89
Resistance of tower structure (Ω)	R1	15.6243
	R2	17.8563
	R3	15.6243
	R4	33.4087
Inductance of tower structure (μ H)	L1	2.9165
	L2	3.332
	L3	2.9165
	L4	6.2497
Tower height	h1	3.5
	h2	4
	h3	3.5
	h4	17

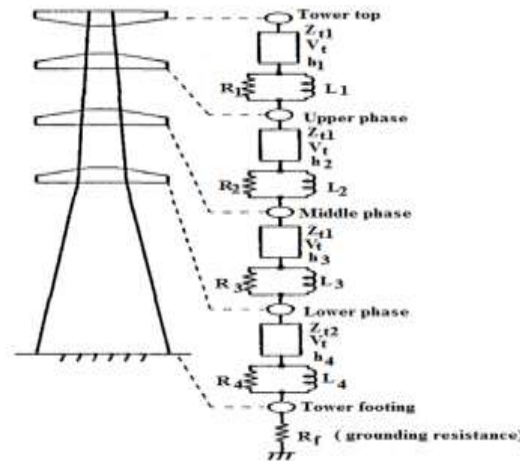

Figure 3. Multi-story Transmission Tower Model

2.4. Back Flashover Model

The shield wires have been located so as to minimize the number of lightning strokes that terminate on the phase conductor. Majority of flashes and strokes terminate on the overhead ground wire. When a shield wire is hit by lightning, the current will propagate in both directions along the shield wire and down the transmission tower in the propagation path. When the electric stress between the conductor and the cross-arm exceeds the critical withstand voltage of the string the back flashover occurs. Lightning impulse withstand voltage level of the insulator string is not a unique number. The insulator string may withstand a high magnitude impulse voltage which has a short duration even if it has failed to withstand a lower magnitude impulse voltage with longer duration. A simplified expression of withstanding voltage capability for an insulator string is calculated as [14, 15].

$$V_{fo} = K_1 + \frac{K_2}{t^{0.75}} \tag{7}$$

Where V_{fo} is flashover voltage, kV, K_1 is 400 L, K_2 is 710 L, L is the insulator string length, m, and t is elapsed time after lightning stroke in μs .

The back flashover mechanism of the insulator string can be represented by volt –time curves. When a back flashover might occur, the insulator string length is taken to be 2.07 m for 66 kV transmission tower system, lightning impulse withstand voltage of the insulator string can be represented by volt- time curve as shown in Figure 4.

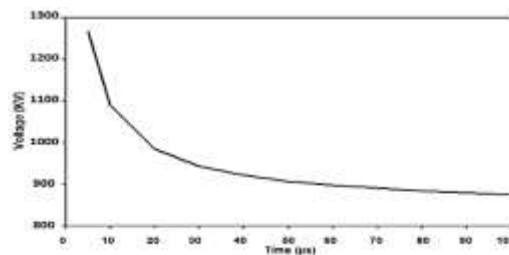

Figure 4. V-t curve of the 66 kV Insulator String

3. Simulation Results

The 66 kV double circuit distribution tower has been modeled using ATP program as shown in Figure 5. The span length of this system is 300 m. The model under study consists of

number of tower sections, each section consists of distribution line sections and a lumped constant consisting of a damping resistance shunted by an inductance representing each tower. In order to take into account the effect of AC steady state voltage of the line on a lightning surge, the transmission line is connected to AC voltage source.

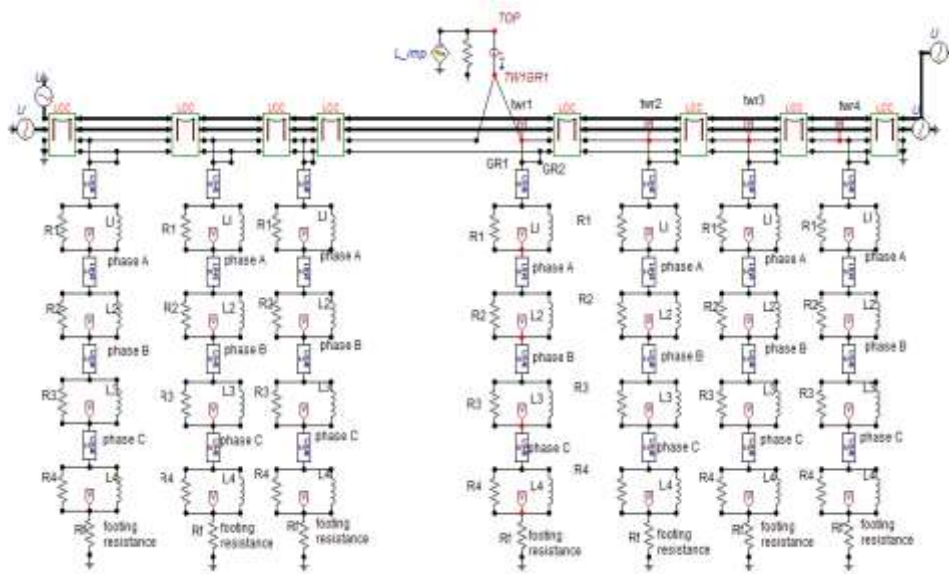

Figure 5. ATP Double Circuit 66 kV Transmission Tower Model

3.1. Front Time of Lightning Stroke Current

A lightning flash generally consists of several strokes which are lower charges, negative or positive, from the cloud to the ground. The first stroke is most often more severe than the subsequent strokes [3]. As shown in Figure 4, impulse voltage withstand capability of the insulator string depends on the front time of lightning strokes. In order to investigate the effect of front time of lightning stroke current, lightning stroke current has a value of 34 kA and different wave front and wave tail times i.e. 1/30.2 μ s, 1.2/50 μ s, 2/77.5 μ s and 3/75 μ s as shown in figure 6 is used to simulate lightning induced voltage across the insulator strings at upper, middle and lower phases, when the lightning stroke hits one of the two tower ground wires [16-21]. Figure 7 compares the induced voltage waveforms at the top of tower 1 with various front time of lightning stroke. The induced voltages at three phases (upper, middle, and lower) of tower 1 with various front time of lightning stroke are shown in figure 8, it is noticed that the shorter front wave time increases the induced voltage, also it is noticed that as front wave time increases the induced voltage decreases and in turn the time to clear the overvoltage increases. These findings are in agreement with J.P. Silva, et al., [14] and Ossama E. Gouda, et al., [15].

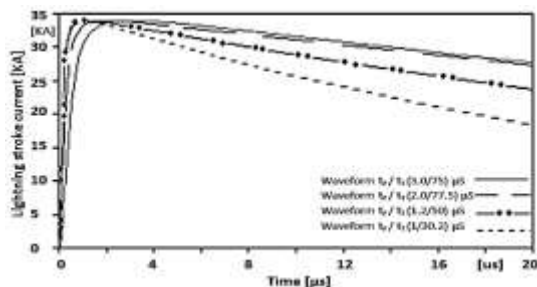

Figure 6. Lightning Source Wave Shape with Various Front Times

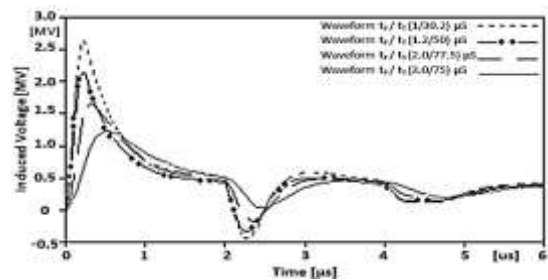
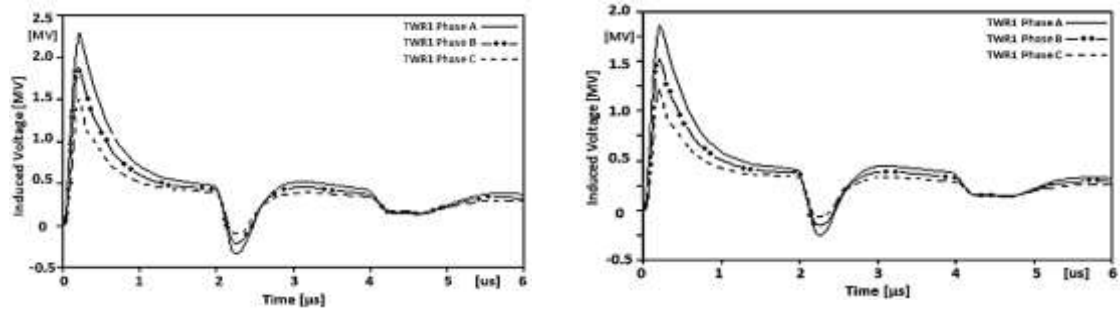
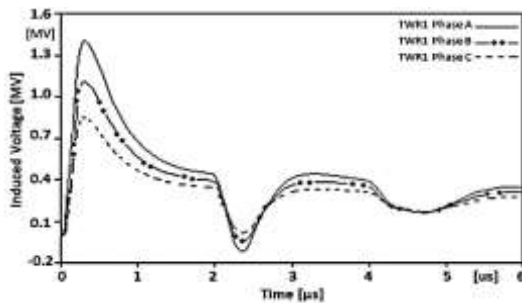

Figure 7. Induced Voltage at Top of Tower 1 with Various Front Time of Lightning Current



a) Induced Voltages of Phases A, B and C at Lightning Stroke Current Waveform 1.0/30.2 μ s

b) Induced Voltages of Phases A, B and C at Lightning Stroke Current Waveform 1.2/50 μ s



c) Induced voltages of phases A, B and C at Lightning Stroke Current Waveform 2.0/77.5 μ s

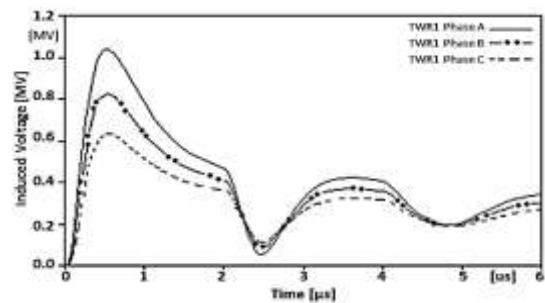

d) Induced Voltages of Phases A, B and C at Lightning Stroke Current Waveform 3.0/75 μ s

Figure 8. Induced Voltage at Three Phases of Tower 1 with Various Front Time of Lightning Current

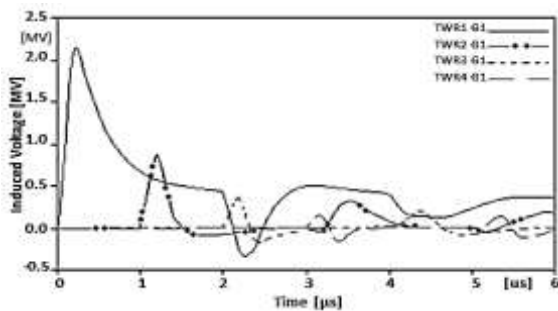

Figure 9. Induced voltage at the First Ground Wire (G1) for Various Striking Distance (Towers 1, 2, 3, and 4)

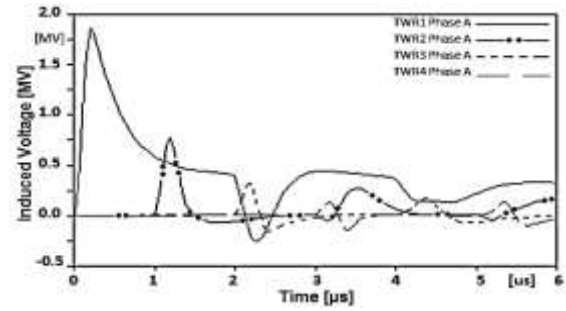

Figure 10. Induced Voltage at the Upper Phase (Phase A) for Various Striking Distance (Towers 1, 2, 3, and 4)

3.2. Striking Distance

To investigate the effect of striking distance on the induced voltages, a lightning stroke current of 34 kA (1.2/50 μ s), hits one of the two ground wires (G1). Figure 9 shows the induced voltage waveforms on the shield wire (G1), at various striking distance, $d= 0, 300, 600, 900$ m (towers 1, 2, 3, and 4). Figure 10 shows the induced voltage at the upper phase (phase A), which is the nearest phase to stroke point, at various distance, $d= 0, 300, 600,$ and 900 m. It is noticed that the induced voltage magnitude decreases with increasing striking distance. Its highest value is at the point which is the nearest to the lightning stroke current and its smallest

value is at the point which is farther to the lightning strike point. Thus the almost have the same waveform. It is also noticed that there is a delay time introduced in the induced voltage waveforms. The time delay seen in the induced voltage waveforms corresponds to the time taken for the electromagnetic field produced by the lightning current to travel to the respective observations points.

3.3. The Peak of the Lightning Current

Figure 11 shows the induced voltage waveforms on the shield wire (G1) of tower 1, at different peak values of lightning stroke current (20, 34, 50 and 80 kA). Figure 12 shows the induced voltage at the upper phase (phase A), which is the nearest phase to stroke point with various peaks of lightning current values. It is noticed that the magnitude of the induced voltage increases with the increasing the peak of lightning current.

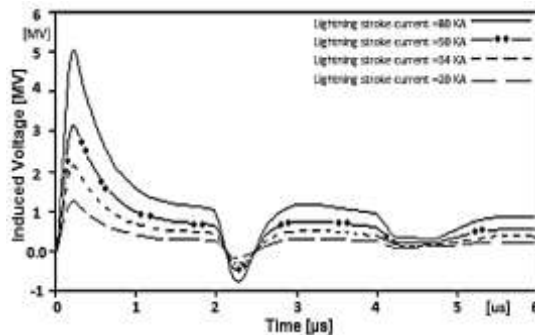

Figure 11. The induced Voltage at Top of Tower 1 (G1) with Various Peaks of Lightning Current

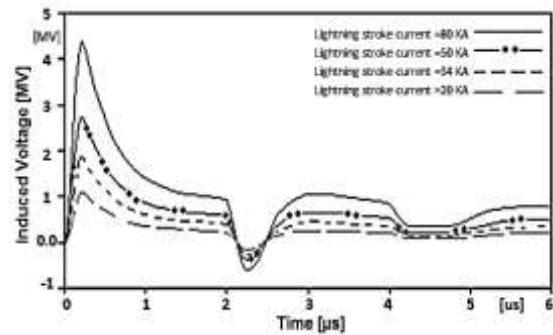

Figure 12. The induce Voltage at the Upper Phase (phase A) with Various Peaks of Lightning Current

3.4. The Effect of Counterpoise Wire of Overhead Transmission Tower

To improve the reliability of overhead power transmission and distribution lines and protecting it from outage, also to protect the tower footing resistance from damage, in this section the effect of counterpoise wires on the insulator strings induced voltages will be discussed by using ATP program, to reduce the chance of a high magnitude stroke causing a back flashover. The counterpoise wires are represented by resistance and inductance in series and their values are calculated by the equations 8 and 9 [17].

$$R = \frac{\rho x}{a} \quad (8)$$

Where R is the counterpoise resistance, ohm, ρ is the resistivity of counterpoise wire material, in $\Omega \cdot m$, x is the length of the counterpoise wire in meters, a is the wire cross sectional area in m^2 . The inductance of counterpoise wire is calculated by [19].

$$L = 0.2x \left[\ln \left(\frac{2x}{r} \right) - 1 \right] \mu H \quad (9)$$

Where x is the length of the counterpoise wire, r is the radius of the counterpoise wire in meters. In this study copper material wires with resistivity $1.68 \times 10^{-8} \Omega \cdot m$ is used, with cross sectional area of 20 mm^2 , and the wire length is 300 m (the span between two towers), are added to reduce the resistance of each tower ground and provides a parallel path with the overhead ground wire for the return of fault current.

The induced voltage across the tower three phases without and with using counterpoise wires at tower footing are compared, the results are given in Figure 13. The footing resistances

induced voltages of tower 1 without and with using counterpoise wire are compared in Figure 14. It is noticed that the induced voltage magnitude across insulator string and ground induced voltage decreases with using protection of counterpoise wires. It is also noticed that there is less chance of a back flashover occurrence because using of counterpoise wires decreases the induced voltage at tower insulator strings and at tower footing, using of counterpoise wires may protect the line from outage and also protect tower footing resistance from damage.

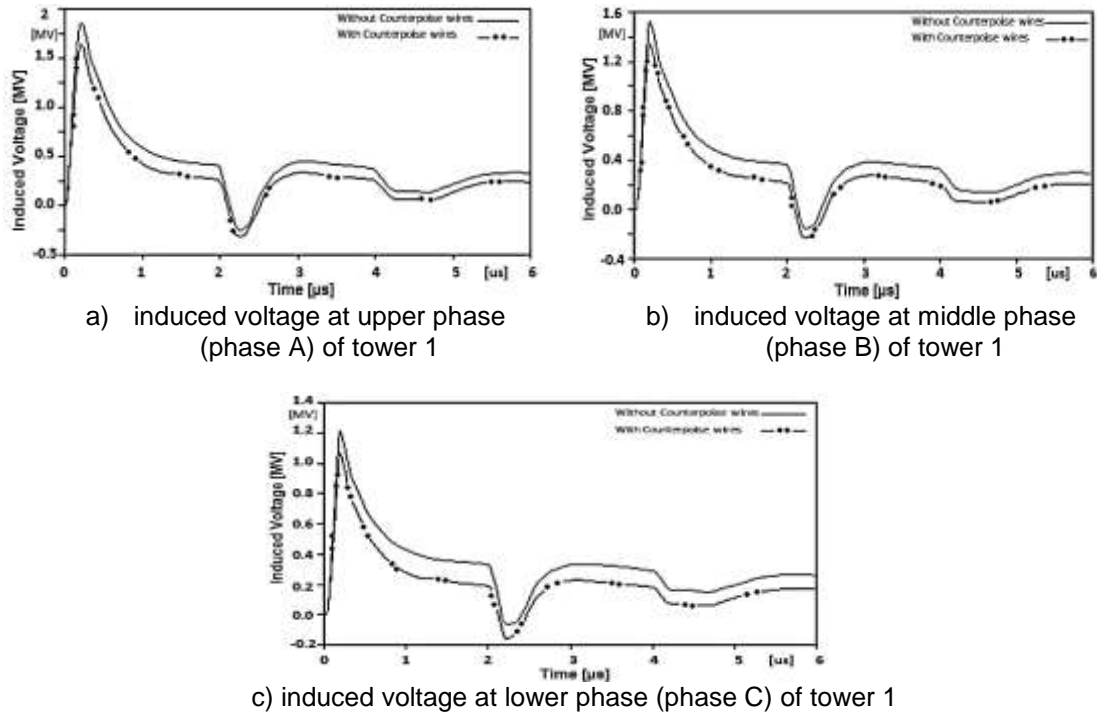

Figure 13. Induced Voltages at Tower Three Phases Without and with using Counterpoise Wire

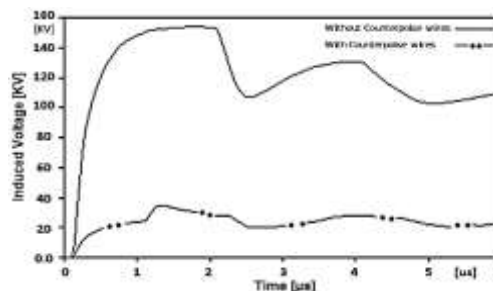

Figure 14. Footing Resistance Induced Voltage of Tower 1 Without and with using Counterpoise Wire

4. Conclusion

This paper has described an analysis of factors affected the back flashover voltage across phase insulator string in 66 kV distribution. Factors of this study include the modeling of transmission tower, magnitude and front time of lightning stroke, striking distance, and effect of counterpoise wires of the overhead transmission lines. All components of the system under study are simulated by using ATP program.

As seen from the simulation results, the induced voltage magnitude decreases with the increase of striking distance, its highest value at the upper phase as it is the nearest to the lightning stroke current (shield wire) and its smallest at the lower phase as it is the farthest to

the lightning strike point and they almost have the same waveform. Also, it is noticed that there is a delay introduced in the induced voltage waveforms. The time delay seen in the induced voltage waveforms is corresponding to the time taken for the electromagnetic field produced by the lightning current to travel to the respective observation points.

Also, it is noticed that, the shorter front time of lightning stroke current will increase the lightning induced over voltage across phase insulator string and in turn will reduce the clearance time of back flashover.

Finally, the use of counterpoise wires decreases the induced voltage at tower insulator strings and at tower footing, so using of counterpoise wires may protect the line from outages and tower footing resistance from damage.

References

- [1] Gomez P, Uribe FA. The numerical Laplace Transform: An Accurate Technique for Analyzing Electromagnetic Transients on Power System Devices. *International Journal of Electrical Power and Energy Systems*. 2009; 31(2-3): 116-123.
- [2] Bank Tavakoli MR, Vahidi B, Hosseinian SH. Discrete-Event Simulation of the Shielding Failure of the Arrester Protected Overhead-Lines to Evaluate Risk of Flashover. *International Journal of Electrical Power and Energy Systems*. 2008; 30(10): 614-623.
- [3] P Chowdhuri, AK *Parameters of Lightning Strokes and their Effect on Power System*. Transmission and Distribution Conference and Exposition (IEEE/PES). Atlanta, GA. 2001; 2: 1047-1051.
- [4] LV Bewley. Traveling Waves on Transmission Systems. *Transactions of the American Institute of Electrical Engineers (IEEE)*. 2009; 50(2): 532-550.
- [5] AR Hileman. *Insulation Coordination for Power Systems*. New York: Marcel Dekker. 1989.
- [6] Dwight HB. Calculation of the resistances to ground. *Electr. Eng.* 1936; 55: 1319-1328.
- [7] ED Sunde. *Earth Conduction Effects in Transmission Systems*. 2nd ed. New York: Dover. 1968.
- [8] A Ametani, N Nagaoka, T Funabashi, N Inoue. *Tower Structure Effect on a Back-Flashover Phase*. Proc. of Int. Conf. on Power Systems Transients (IPST'05). Montreal, Canada. 2005.
- [9] M Ishii, T Kawamura, T Kouno, E Ohsaki, K Shiokawa, K Murotani, T Higuchi. Multistory Transmission Tower Model for Lightning Surge Analysis. *IEEE Transactions on Power Delivery*. 2002; 6(3): 1327-1335.
- [10] T Yamada, A Mochizuki, J Sawada, E Zaima, T Kawamura, AM Ishii, S Kato. Experimental evaluation of a UHV tower model for lightning surge analysis. *IEEE Transactions on Power Delivery*. 2002; 10(1): 393-402.
- [11] IEEE Working Group on Lightning Performance of Transmission Lines. 1243-1997. *IEEE Guide for Improving The lightning Performance of Transmission Lines*. 1997.
- [12] B Marungsri, S Boonpoke, A Rawangpai, A Oonsivilai, C Kritayakornpong. Study of Tower Grounding Resistance Effected Back Flashover to 500 kV Transmission Line in Thailand by using ATP/EMTP. *International Journal of Electrical, Computer, Energetic, Electronic and Communication Engineering*. 2008; 2(6).
- [13] JA Gutierrez R, P Menreno, L Guardado, L Naredo. *Comarison of Transmission Line models for Evaluating Lightning Performance*. IEEE Bologna Power Tech. Conference. Bologna, Italy. 2003; 4.
- [14] JP Silva AAEA, Arau'jo, JOS Paulino. Calculation of lightning-induced voltages with Rusck's method in EMTP-part II: effects of lightning parameter variations. *Electric Power Systems Research*. 2002; 61: 133-137.
- [15] Ossama E Gouda, Adel Z ElDein, Ghada M Amer. *Parameters Affecting the back Flashover across the Overhead Transmission Line Insulator Caused by Lightning*. Proceeding of 14th International Middle East Power Systems Conference (MEPCON'10). Cairo University, Egypt. 2010.
- [16] RB Anderson, AJ Erikson. Lightning Parameters for Engineering Applications. *ELECTRA* 69. 1980: 65-102.
- [17] Diendorfer G. Induced voltage on an overhead line due to nearby lightning. *IEEE Transactions EMC*. 1990; 32(4): 292-299.
- [18] Cooray SV. Power and energy dissipation in negative lightning return strokes. *Atmos. Res.* 2014; 149: 359-371
- [19] Izadi M, Kadir MZAA, Gomes C, Wan Ahmed WF. An analytical second-FDTD method for evaluation of electric and magnetic at intermediate distances from lightning fields. *Progr. Electromagn. Res.* 2010; 110: 329-352
- [20] Rusck S. Induced lightning over voltages on power transmission lines with special reference to the overvoltage protection of low voltage networks. *Trans. R. Inst. Technol.* 1958; 120: 1-118.
- [21] Ametani A, Kawamura T. A Method of a Lightning Surge Analysis Recommended in Japan Using EMTP. *IEEE Trans. on Power Delivery*. 2005; 20(2): 867-875.